

LP5996

Dual Linear Regulator with 300mA and 150mA Outputs

General Description

The LP5996 is a dual low dropout regulator. The first regulator can source 150mA, while the second is capable of sourcing 300mA.

The LP5996 provides 1.5% accuracy requiring an ultra low quiescent current of 35 μ A. Separate enable pins allow each output of the LP5996 to be shut down, drawing virtually zero current.

The LP5996 is designed to be stable with small footprint ceramic capacitors down to 1 μ F.

The LP5996 is available in fixed output voltages and comes in a 10 pin, 3mm x 3mm, LLP package. .

Features

- 2 LDO Outputs with Independent Enable
- 1.5% Accuracy at Room Temperature, 3% over Temperature
- Thermal Shutdown Protection
- Stable with Ceramic Capacitors

Key Specifications

- | | |
|-----------------------------------|----------------|
| ■ Input Voltage Range | 2.0V to 6.0V |
| ■ Low Dropout Voltage | 210mV at 300mA |
| ■ Ultra-Low I_Q (enabled) | 35 μ A |
| ■ Virtually Zero I_Q (disabled) | <10nA |

Package

All available in Lead Free option.
 10 pin LLP 3mm x 3mm

For other package options contact your NSC sales office.

Applications

- Cellular Handsets
- PDA's
- Wireless Network Adaptors

Typical Application Circuit

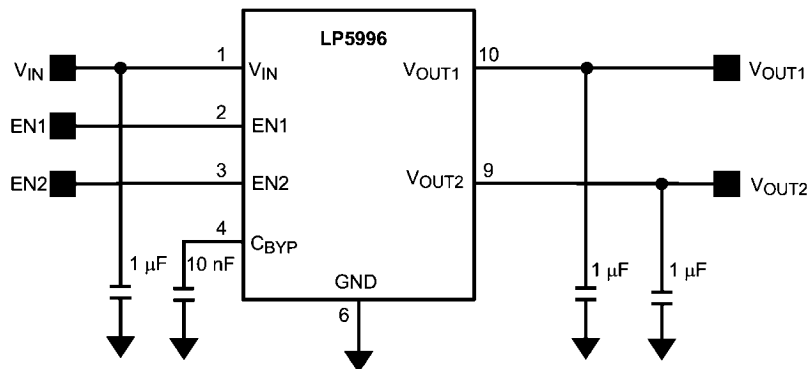

20171501

Functional Block Diagram

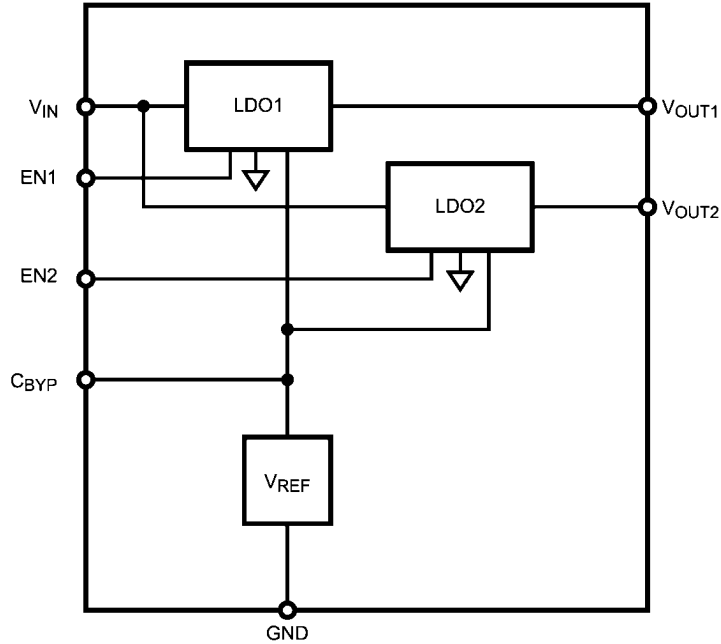

20171506

Pin Descriptions

LLP-10 Package

Pin No	Symbol	Name and Function
1	V_{IN}	Voltage Supply Input. Connect a $1\mu\text{F}$ capacitor between this pin and GND.
2	EN1	Enable Input to Regulator 1. Active high input. High = On. Low = OFF.
3	EN2	Enable Input to Regulator 2. Active high input. High = On. Low = OFF.
4	C_{BYP}	Internal Voltage Reference Bypass. Connect a 10nF capacitor from this pin to GND to reduce noise and improve line transient and PSRR. This pin may be left open.
5	N/C	No Connection. Do not connect to any other pin.
6	GND	Common Ground pin. Connect externally to exposed pad.
7	N/C	No Connection. Do not connect to any other pin.
8	N/C	No Connection. Do not connect to any other pin.
9	V_{OUT2}	Output of Regulator 2. 300mA maximum current output. Connect a $1\mu\text{F}$ capacitor between this pin to GND.
10	V_{OUT1}	Output of Regulator 1. 150mA maximum current output. Connect a $1\mu\text{F}$ capacitor between this pin to GND.
Pad	GND	Common Ground. Connect to Pin 6.

Connection Diagram

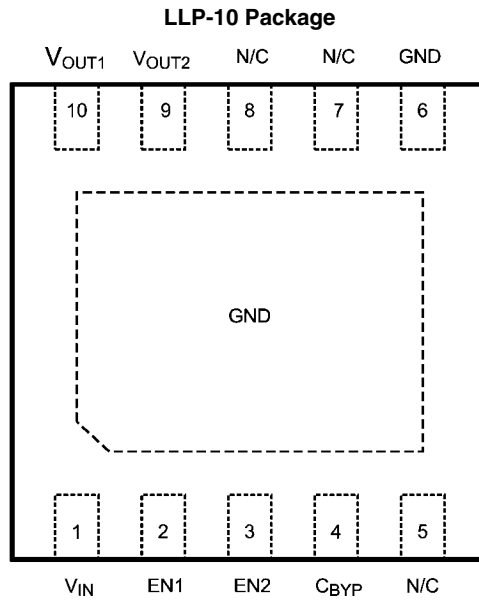

Top View

See NS package number **SDA10A** 20171503

Ordering Information (LLP-10)

For other voltage options, please contact your local NSC sales office.

Output Voltage (V)		Order Number	Spec	Package Marking	Supplied As
Vout1	Vout2				
0.8	3.3	LP5996SD-0833	NOPB	L176B	1000 Units, Tape-and-Reel
		LP5996SDX-0833	NOPB		4500 Units, Tape-and-Reel
		LP5996SD-0833			1000 Units, Tape-and-Reel
		LP5996SDX-0833			4500 Units, Tape-and-Reel
1.0	1.8	LP5996SD-1018	NOPB	L224B	1000 Units, Tape-and-Reel
		LP5996SDX-1018	NOPB		4500 Units, Tape-and-Reel
		LP5996SD-1018			1000 Units, Tape-and-Reel
		LP5996SDX-1018			4500 Units, Tape-and-Reel
1.5	2.5	LP5996SD-1525	NOPB	L177B	1000 Units, Tape-and-Reel
		LP5996SDX-1525	NOPB		4500 Units, Tape-and-Reel
		LP5996SD-1525			1000 Units, Tape-and-Reel
		LP5996SDX-1525			4500 Units, Tape-and-Reel
1.8	3.3	LP5996SD-1833	NOPB	L225B	1000 Units, Tape-and-Reel
		LP5996SDx-1833	NOPB		4500 Units, Tape-and-Reel
		LP5996SD-1833			1000 Units, Tape-and-Reel
		LP5996SDx-1833			4500 Units, Tape-and-Reel
2.5	3.3	LP5996SD-2533	NOPB	L226B	1000 Units, Tape-and-Reel
		LP5996SDx-2533	NOPB		4500 Units, Tape-and-Reel
		LP5996SD-2533			1000 Units, Tape-and-Reel
		LP5996SDx-2533			4500 Units, Tape-and-Reel
2.8	2.8	LP5996SD-2828	NOPB	L180B	1000 Units, Tape-and-Reel
		LP5996SDX-2828	NOPB		4500 Units, Tape-and-Reel
		LP5996SD-2828			1000 Units, Tape-and-Reel
		LP5996SDX-2828			4500 Units, Tape-and-Reel
3.0	3.0	LP5996SD-3030	NOPB	L181B	1000 Units, Tape-and-Reel
		LP5996SDX-3030	NOPB		4500 Units, Tape-and-Reel
		LP5996SD-3030			1000 Units, Tape-and-Reel
		LP5996SDX-3030			4500 Units, Tape-and-Reel
3.0	3.3	LP5996SD-3033	NOPB	L179B	1000 Units, Tape-and-Reel
		LP5996SDX3033	NOPB		4500 Units, Tape-and-Reel
		LP5996SD-3033			1000 Units, Tape-and-Reel
		LP5996SDX3033			4500 Units, Tape-and-Reel
3.3	0.8	LP5996SD-3308	NOPB	L205B	1000 Units, Tape-and-Reel
		LP5996SDX-3308	NOPB		4500 Units, Tape-and-Reel
		LP5996SD-3308			1000 Units, Tape-and-Reel
		LP5996SDX-3308			4500 Units, Tape-and-Reel
3.3	3.3	LP5996SD-3333	NOPB	L182B	1000 Units, Tape-and-Reel
		LP5996SDX-3333	NOPB		4500 Units, Tape-and-Re
		LP5996SD-3333			1000 Units, Tape-and-Reel
		LP5996SDX-3333			4500 Units, Tape-and-Re

Absolute Maximum Ratings

(Notes 1, 2)

If Military/Aerospace specified devices are required, please contact the National Semiconductor Sales Office/Distributors for availability and specifications.

Input Voltage	-0.3V to 6.5V
V_{OUT1} , V_{OUT2} , EN1, and EN2 Voltage to GND	-0.3V to ($V_{IN} + 0.3V$) with 6.5V (max)
Junction Temperature (T_{J-MAX})	150°C
Lead/Pad Temp. (Note 3)	235°C
Storage Temperature	-65°C to 150°C
Continuous Power Dissipation Internally Limited(Notes 4)	
ESD Rating(Notes 5)	

Human Body Model	2.0kV
Machine Model	200V

Operating Ratings

 (Notes 1, 2)

Input Voltage	2.0V to 6.0V
EN1, EN2 Voltage	0 to ($V_{IN} + 0.3V$) to 6.0V (max)
Junction Temperature	-40°C to 125°C
Ambient Temperature T_A Range (Note 6)	-40°C to 85°C

Thermal Properties

 (Note 1)

Junction To Ambient Thermal Resistance(Notes 7)	
θ_{JA} LLP-10 Package	55°C/W

Electrical Characteristics

 (Notes 2, 8)

Unless otherwise noted, $V_{EN} = 950mV$, $V_{IN} = V_{OUT} + 1.0V$, or 2.0V, whichever is higher, where V_{OUT} is the higher of V_{OUT1} and V_{OUT2} . $C_{IN} = 1 \mu F$, $I_{OUT} = 1 mA$, $C_{OUT1} = C_{OUT2} = 1.0 \mu F$.

Typical values and limits appearing in normal type apply for $T_A = 25^\circ C$. Limits appearing in **boldface** type apply over the full junction temperature range for operation, -40 to +125°C.

Symbol	Parameter	Conditions	Typ	Limit		Units
				Min	Max	
V_{IN}	Input Voltage	(Note 9)		2	6	V
ΔV_{OUT}	Output Voltage Tolerance	$I_{OUT} = 1mA$ $1.5V < V_{OUT} \leq 3.3V$		-2.5	+2.5	%
				-3.75	+3.75	
		$V_{OUT} \leq 1.5V$		-2.75	+2.75	
				-4	+4	
	Line Regulation Error	$V_{IN} = (V_{OUT(NOM)} + 1.0V)$ to 6.0V	0.03		0.3	%/V
	Load Regulation Error	$I_{OUT} = 1mA$ to 150mA (LDO 1)	85		155	$\mu V/mA$
		$I_{OUT} = 1mA$ to 300mA (LDO 2)	26		85	
V_{DO}	Dropout Voltage (Note 10)	$I_{OUT} = 1mA$ to 150mA (LDO 1)	110		220	mV
		$I_{OUT} = 1mA$ to 300mA (LDO 2)	210		550	
I_Q	Quiescent Current	LDO 1 ON, LDO 2 ON $I_{OUT1} = I_{OUT2} = 0mA$	35		100	μA
		LDO 1 ON, LDO 2 OFF $I_{OUT1} = 150mA$	45		110	
		LDO 1 OFF, LDO 2 ON $I_{OUT2} = 300mA$	45		110	
		LDO 1 ON, LDO 2 ON $I_{OUT1} = 150mA$, $I_{OUT2} = 300mA$	70		170	
		$V_{EN1} = V_{EN2} = 0.4V$	0.5		10	
I_{SC}	Short Circuit Current Limit	LDO 1	420		750	mA
		LDO 2	550		840	
I_{OUT}	Maximum Output Current	LDO 1			150	mA
		LDO 2			300	

Symbol	Parameter	Conditions	Typ	Limit		Units	
				Min	Max		
PSRR	Power Supply Rejection Ratio (Note 11)	f = 1kHz, I _{OUT} = 1mA to 150mA C _{BYP} = 10nF	LDO1	58			dB
			LDO2	70			
		f = 20kHz, I _{OUT} = 1mA to 150mA C _{BYP} = 10nF	LDO1	45			
			LDO2	60			
e _n	Output noise Voltage (Note 11)	BW = 10Hz to 100kHz C _{BYP} = 10nF	V _{OUT} = 0.8V	36			μV _{RMS}
			V _{OUT} = 3.3V	75			
T _{SHUTDOWN}	Thermal Shutdown	Temperature	160			°C	
		Hysteresis	20				
Enable Control Characteristics							
I _{EN}	Input Current at V _{EN1} or V _{EN2}	V _{EN} = 0.0V	0.005		0.1	μA	
		V _{EN} = 6V	2		5		
V _{IL}	Low Input Threshold				0.4	V	
V _{IH}	High Input Threshold			0.95		V	
Timing Characteristics							
T _{ON}	Turn On Time (Note 11)	To 95% Level C _{BYP} = 10nF	300			μs	
Transient Response	Line Transient Response δV _{OUT} (Note 11)	T _{rise} = T _{fall} = 10μs δV _{IN} = 1V C _{BYP} = 10nF		20		mV (pk - pk)	
			Load Transient Response δV _{OUT} (Note 11)	T _{rise} = T _{fall} = 1μs	LDO 1 I _{OUT} = 1mA to 150mA		175
	LDO 2 I _{OUT} = 1mA to 300mA	150					

Note 1: Absolute Maximum Ratings are limits beyond which damage can occur. Operating Ratings are conditions under which operation of the device is guaranteed. Operating Ratings do not imply guaranteed performance limits. For guaranteed performance limits and associated test conditions, see the Electrical Characteristics tables.

Note 2: All Voltages are with respect to the potential at the GND pin.

Note 3: For detailed soldering specifications and information, please refer to National Semiconductor Application Note AN-1187, Leadless Leadframe Package.

Note 4: Internal thermal shutdown circuitry protects the device from permanent damage.

Note 5: The human body model is 100pF discharged through a 1.5kΩ resistor into each pin. The machine model is a 200pF capacitor discharged directly into each pin.

Note 6: The maximum ambient temperature (T_{A(max)}) is dependant on the maximum operating junction temperature (T_{J(max-op)} = 125°C), the maximum power dissipation of the device in the application (P_{D(max)}), and the junction to ambient thermal resistance of the part/package in the application (θ_{JA}), as given by the following equation: T_{A(max)} = T_{J(max-op)} - (θ_{JA} × P_{D(max)}).

Note 7: Junction to ambient thermal resistance is dependant on the application and board layout. In applications where high maximum power dissipation is possible, special care must be paid to thermal dissipation issues in board design.

Note 8: Min Max limits are guaranteed by design, test or statistical analysis. Typical numbers are not guaranteed, but do represent the most likely norm.

Note 9: V_{IN(MIN)} = V_{OUT(NOM)} + 0.5V, or 2.0V, whichever is higher.

Note 10: Dropout voltage is voltage difference between input and output at which the output voltage drops to 100mV below its nominal value. This parameter only for output voltages above 2.0V

Note 11: This electrical specification is guaranteed by design.

Output Capacitor, Recommended Specifications

Symbol	Parameter	Conditions	Nom	Limit		Units
				Min	Max	
C _{OUT}	Output Capacitance	Capacitance (Note 12)	1.0	0.7		μF
		ESR		5	500	mΩ

Note 12: The Capacitor tolerance should be 30% or better over temperature. The full operating conditions for the application should be considered when selecting a suitable capacitor to ensure that the minimum value of capacitance is always met. Recommended capacitor is X7R. However, depending on the application, X5R, Y5V and Z5U can also be used. (See capacitor section in Applications Hints).

Typical Performance Characteristics. Unless otherwise specified, $C_{IN} = 1.0\mu\text{F}$ Ceramic, $C_{OUT1} = C_{OUT2} = 1.0\mu\text{F}$ Ceramic, $C_{BYP} = 10\text{nF}$, $V_{IN} = V_{OUT2(NOM)} + 1.0\text{V}$, $T_A = 25^\circ\text{C}$, $V_{OUT1(NOM)} = 3.3\text{V}$, $V_{OUT2(NOM)} = 3.3\text{V}$, Enable pins are tied to V_{IN} .

Output Voltage Change vs Temperature

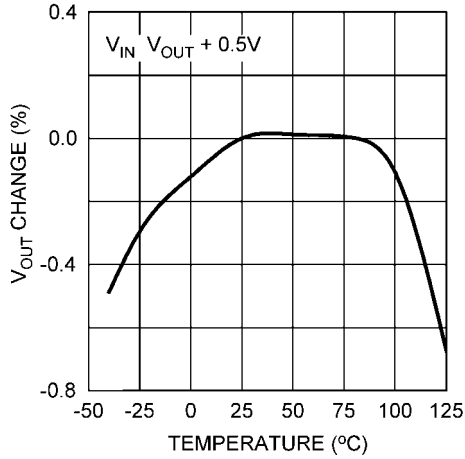

20171510

Ground Current vs Load Current, LDO1

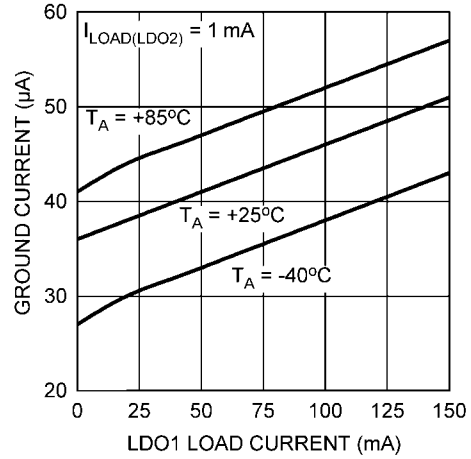

20171513

Ground Current vs Load Current, LDO2

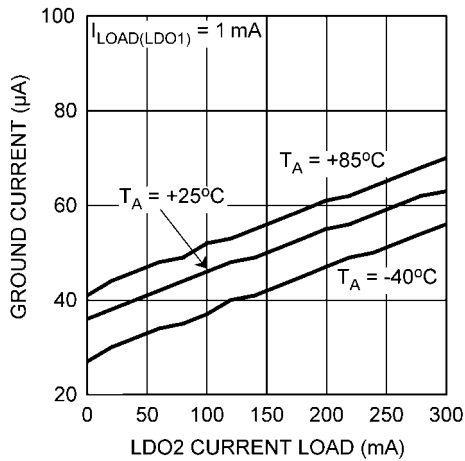

20171514

Ground Current vs V_{IN} , $I_{LOAD} = 1\text{ mA}$

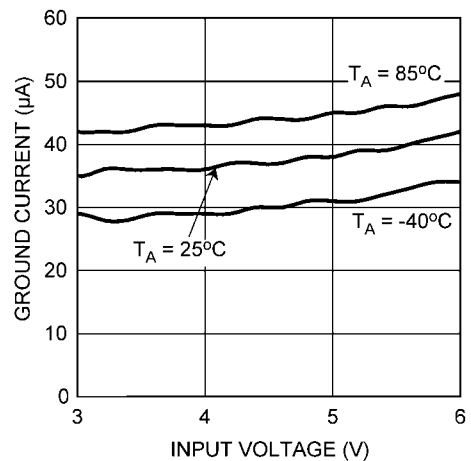

20171515

Dropout Voltage vs I_{LOAD} , LDO1

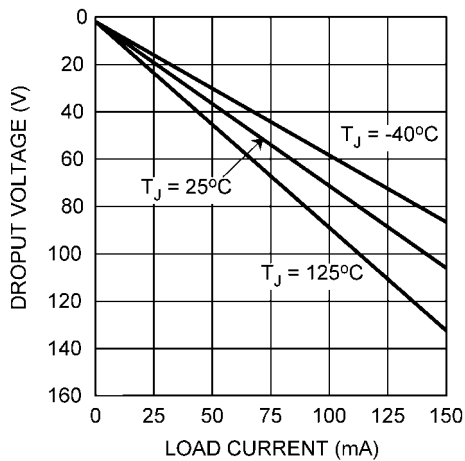

20171511

Dropout Voltage vs I_{LOAD} , LDO2

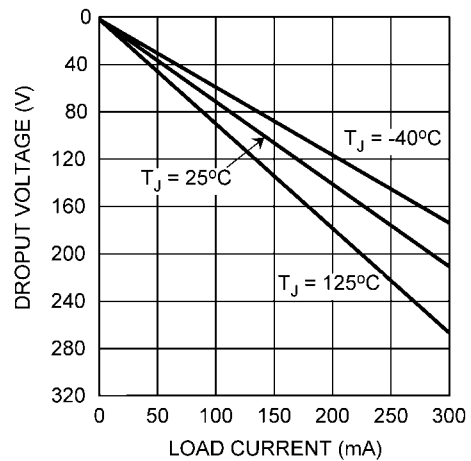

20171512

Line Transient, $C_{BYP} = 10nF$

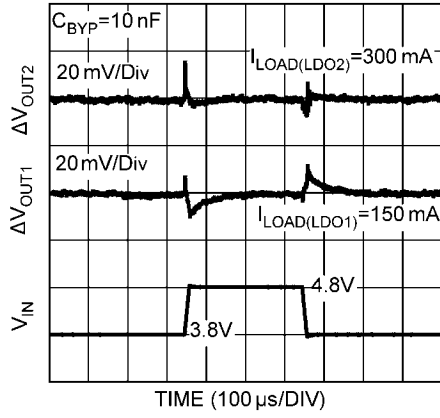

20171519

Line Transient, $C_{BYP} = 0$

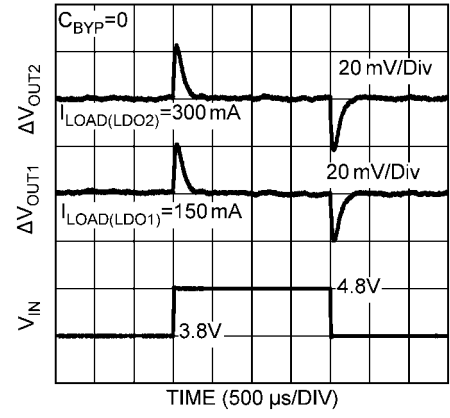

20171520

Load Transient, LDO1

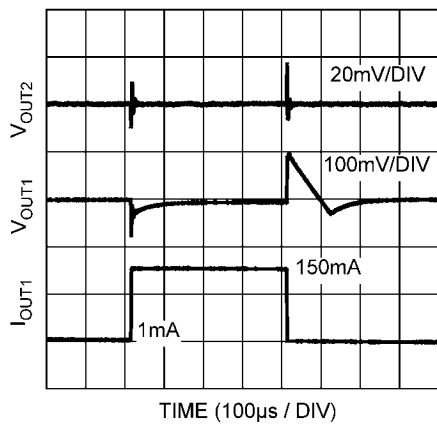

20171550

Load Transient, LDO2

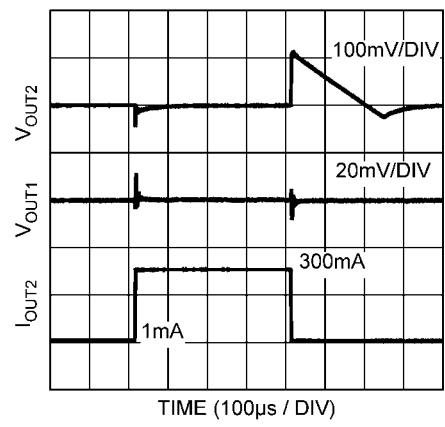

20171551

Noise Density, LDO1

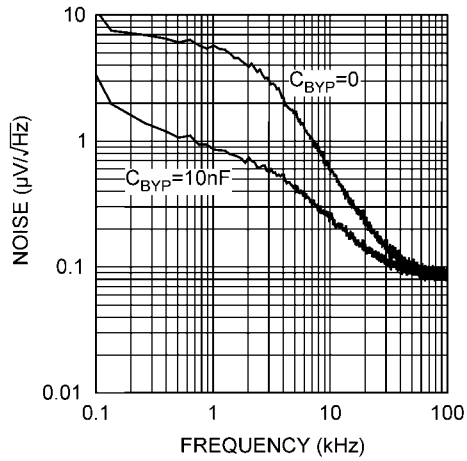

20171556

Noise Density, LDO2

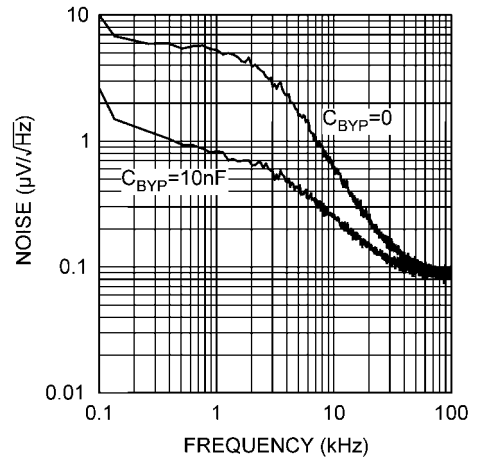

20171557

Short Circuit Current, LDO1

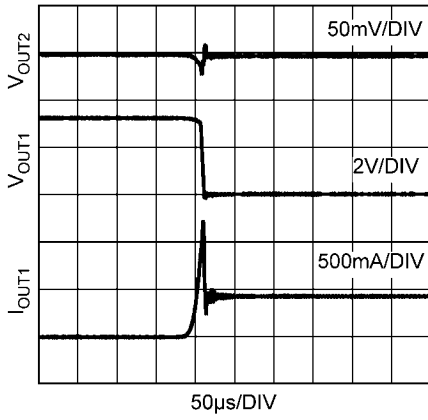

20171552

Short Circuit Current, LDO2

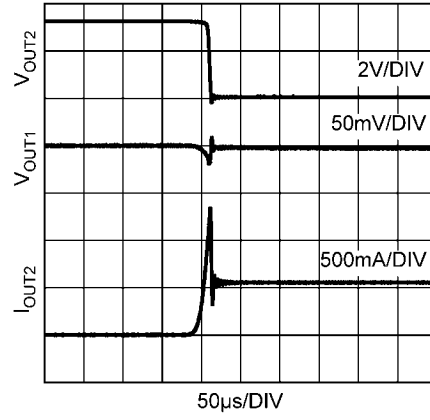

20171553

Power Supply Rejection Ratio, LDO1

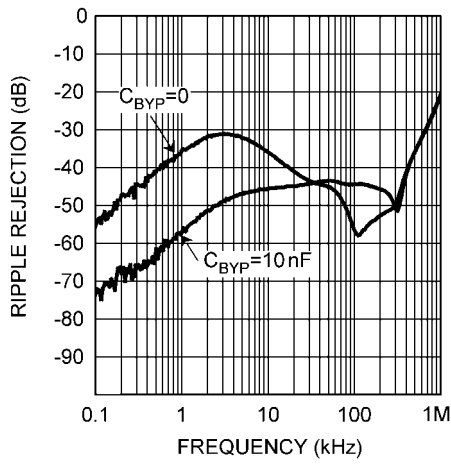

20171555

Power Supply Rejection Ratio, LDO2

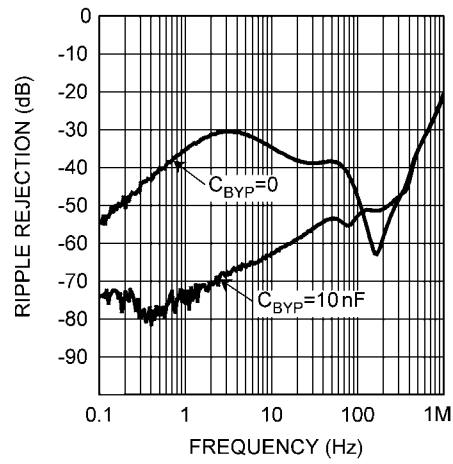

20171554

Enable Start-up Time, $C_{BYP} = 0$

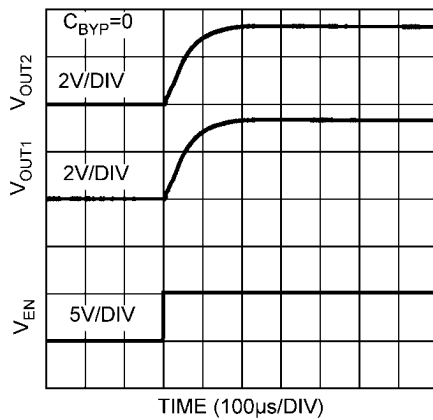

20171560

Enable Start-up Time, $C_{BYP} = 10\text{nF}$

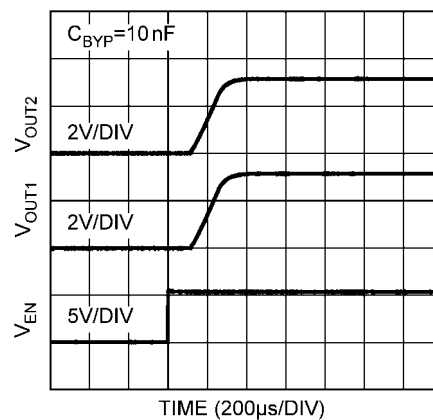

20171561

Application Hints

OPERATION DESCRIPTION

The LP5996 is a low quiescent current, power management IC, designed specifically for portable applications requiring minimum board space and smallest components. The LP5996 contains two independently selectable LDOs. The first is capable of sourcing 150mA at outputs between 0.8V and 3.3V. The second can source 300mA at an output voltage of 0.8V to 3.3V.

INPUT CAPACITOR

An input capacitor is required for stability. It is recommended that a 1.0 μ F capacitor be connected between the LP5996 input pin and ground (this capacitance value may be increased without limit).

This capacitor must be located a distance of not more than 1cm from the input pin and returned to a clean analogue ground. Any good quality ceramic, tantalum, or film capacitor may be used at the input.

Important: Tantalum capacitors can suffer catastrophic failures due to surge current when connected to a low-impedance source of power (like a battery or a very large capacitor). If a tantalum capacitor is used at the input, it must be guaranteed by the manufacturer to have a surge current rating sufficient for the application.

There are no requirements for the ESR (Equivalent Series Resistance) on the input capacitor, but tolerance and temperature coefficient must be considered when selecting the capacitor to ensure the capacitance will remain approximately 1.0 μ F over the entire operating temperature range.

OUTPUT CAPACITOR

The LP5996 is designed specifically to work with very small ceramic output capacitors. A 1.0 μ F ceramic capacitor (temperature types Z5U, Y5V or X7R) with ESR between 5m Ω to 500m Ω , is suitable in the LP5996 application circuit.

For this device the output capacitor should be connected between the V_{OUT} pin and ground.

It is also possible to use tantalum or film capacitors at the device output, C_{OUT} (or V_{OUT}), but these are not as attractive for reasons of size and cost (see the section Capacitor Characteristics).

The output capacitor must meet the requirement for the minimum value of capacitance and also have an ESR value that is within the range 5m Ω to 500m Ω for stability.

NO-LOAD STABILITY

The LP5996 will remain stable and in regulation with no external load. This is an important consideration in some circuits, for example CMOS RAM keep-alive applications.

CAPACITOR CHARACTERISTICS

The LP5996 is designed to work with ceramic capacitors on the output to take advantage of the benefits they offer. For capacitance values in the range of 0.47 μ F to 4.7 μ F, ceramic capacitors are the smallest, least expensive and have the lowest ESR values, thus making them best for eliminating high frequency noise. The ESR of a typical 1.0 μ F ceramic capacitor is in the range of 20m Ω to 40m Ω , which easily meets the ESR requirement for stability for the LP5996.

For both input and output capacitors, careful interpretation of the capacitor specification is required to ensure correct device operation. The capacitor value can change greatly, depending on the operating conditions and capacitor type.

In particular, the output capacitor selection should take account of all the capacitor parameters, to ensure that the specification is met within the application. The capacitance can vary with DC bias conditions as well as temperature and frequency of operation. Capacitor values will also show some decrease over time due to aging. The capacitor parameters are also dependant on the particular case size, with smaller sizes giving poorer performance figures in general. As an example, *Figure 1* shows a typical graph comparing different capacitor case sizes in a Capacitance vs. DC Bias plot. As shown in the graph, increasing the DC Bias condition can result in the capacitance value falling below the minimum value given in the recommended capacitor specifications table (0.7 μ F in this case). Note that the graph shows the capacitance out of spec for the 0402 case size capacitor at higher bias voltages. It is therefore recommended that the capacitor manufacturers' specifications for the nominal value capacitor are consulted for all conditions, as some capacitor sizes (e.g. 0402) may not be suitable in the actual application.

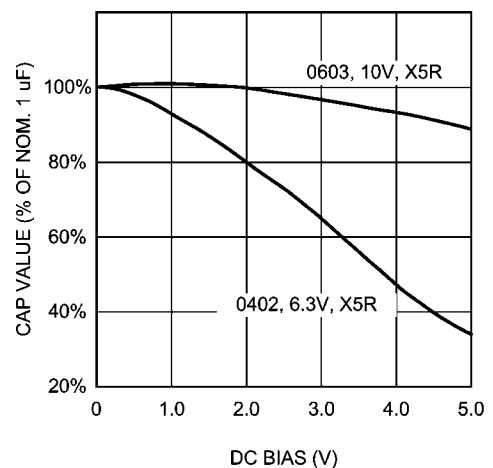

20171540

FIGURE 1. Graph Showing a Typical Variation in Capacitance vs DC Bias

The capacitance value of ceramic capacitors varies with temperature. The capacitor type X7R, which operates over a temperature range of -55 $^{\circ}$ C to +125 $^{\circ}$ C, will only vary the capacitance to within \pm 15%. The capacitor type X5R has a similar tolerance over a reduced temperature range of -55 $^{\circ}$ C to +85 $^{\circ}$ C. Many large value ceramic capacitors, larger than 1 μ F are manufactured with Z5U or Y5V temperature characteristics. Their capacitance can drop by more than 50% as the temperature varies from 25 $^{\circ}$ C to 85 $^{\circ}$ C. Therefore X7R is recommended over Z5U and Y5V in applications where the ambient temperature will change significantly above or below 25 $^{\circ}$ C.

Tantalum capacitors are less desirable than ceramic for use as output capacitors because they are more expensive when comparing equivalent capacitance and voltage ratings in the 0.47 μ F to 4.7 μ F range.

Another important consideration is that tantalum capacitors have higher ESR values than equivalent size ceramics. This means that while it may be possible to find a tantalum capacitor with an ESR value within the stable range, it would have to be larger in capacitance (which means bigger and more costly) than a ceramic capacitor with the same ESR value. It should also be noted that the ESR of a typical tantalum will

increase about 2:1 as the temperature goes from 25°C down to -40°C, so some guard band must be allowed.

ENABLE CONTROL

The LP5996 features active high enable pins for each regulator, EN1 and EN2, which turns the corresponding LDO off when pulled low. The device outputs are enabled when the enable pins are set to high. When not enabled the regulator output is off and the device typically consumes 2nA.

If the application does not require the Enable switching feature, one or both enable pins should be tied to V_{IN} to keep the regulator output permanently on.

To ensure proper operation, the signal source used to drive the enable inputs must be able to swing above and below the specified turn-on/off voltage thresholds listed in the Electrical Characteristics section under V_{IL} and V_{IH} .

BYPASS CAPACITOR

The internal voltage reference circuit of the LP5996 is connected to the C_{BYP} pin via a high value internal resistor. An external capacitor, connected to this pin, forms a low-pass

filter which reduces the noise level on both outputs of the device. There is also some improvement in PSSR and line transient performance. Internal circuitry ensures rapid charging of the C_{BYP} capacitor during start-up. A 10nF, high quality ceramic capacitor with either NPO or COG dielectric is recommended due to their low leakage characteristics and low noise performance.

SAFE AREA OF OPERATION

Due consideration should be given to operating conditions to avoid excessive thermal dissipation of the LP5996 or triggering its thermal shutdown circuit. When both outputs are enabled, the total power dissipation will be $P_{D(LDO1)} + P_{D(LDO2)}$ where $PD = (V_{IN} - V_{OUT}) \times I_{OUT}$ for each LDO

In general, device options which have a large difference in output voltage will dissipate more power with both outputs enabled, due to the input voltage required for the higher output voltage LDO. In such cases, especially at elevated ambient temperature, it may not be possible to operate both outputs at maximum current at the same time.

Physical Dimensions inches (millimeters) unless otherwise noted

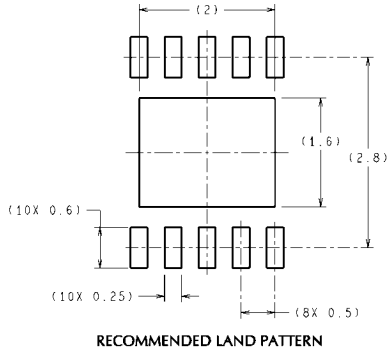

DIMENSIONS ARE IN MILLIMETERS
DIMENSIONS IN () FOR REFERENCE ONLY

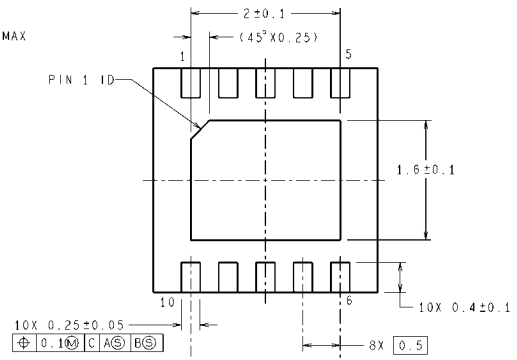
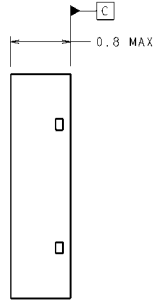
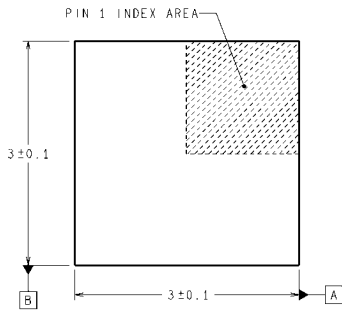
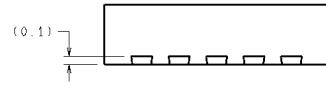

LLP, 10 Lead, Package
NS Package Number SDA10A

SDA10A (Rev A)

Notes

For more National Semiconductor product information and proven design tools, visit the following Web sites at:

Products		Design Support	
Amplifiers	www.national.com/amplifiers	WEBENCH	www.national.com/webench
Audio	www.national.com/audio	Analog University	www.national.com/AU
Clock Conditioners	www.national.com/timing	App Notes	www.national.com/appnotes
Data Converters	www.national.com/adc	Distributors	www.national.com/contacts
Displays	www.national.com/displays	Green Compliance	www.national.com/quality/green
Ethernet	www.national.com/ethernet	Packaging	www.national.com/packaging
Interface	www.national.com/interface	Quality and Reliability	www.national.com/quality
LVDS	www.national.com/lvds	Reference Designs	www.national.com/refdesigns
Power Management	www.national.com/power	Feedback	www.national.com/feedback
Switching Regulators	www.national.com/switchers		
LDOs	www.national.com/lido		
LED Lighting	www.national.com/led		
PowerWise	www.national.com/powerwise		
Serial Digital Interface (SDI)	www.national.com/sdi		
Temperature Sensors	www.national.com/tempsensors		
Wireless (PLL/VCO)	www.national.com/wireless		

THE CONTENTS OF THIS DOCUMENT ARE PROVIDED IN CONNECTION WITH NATIONAL SEMICONDUCTOR CORPORATION ("NATIONAL") PRODUCTS. NATIONAL MAKES NO REPRESENTATIONS OR WARRANTIES WITH RESPECT TO THE ACCURACY OR COMPLETENESS OF THE CONTENTS OF THIS PUBLICATION AND RESERVES THE RIGHT TO MAKE CHANGES TO SPECIFICATIONS AND PRODUCT DESCRIPTIONS AT ANY TIME WITHOUT NOTICE. NO LICENSE, WHETHER EXPRESS, IMPLIED, ARISING BY ESTOPPEL OR OTHERWISE, TO ANY INTELLECTUAL PROPERTY RIGHTS IS GRANTED BY THIS DOCUMENT.

TESTING AND OTHER QUALITY CONTROLS ARE USED TO THE EXTENT NATIONAL DEEMS NECESSARY TO SUPPORT NATIONAL'S PRODUCT WARRANTY. EXCEPT WHERE MANDATED BY GOVERNMENT REQUIREMENTS, TESTING OF ALL PARAMETERS OF EACH PRODUCT IS NOT NECESSARILY PERFORMED. NATIONAL ASSUMES NO LIABILITY FOR APPLICATIONS ASSISTANCE OR BUYER PRODUCT DESIGN. BUYERS ARE RESPONSIBLE FOR THEIR PRODUCTS AND APPLICATIONS USING NATIONAL COMPONENTS. PRIOR TO USING OR DISTRIBUTING ANY PRODUCTS THAT INCLUDE NATIONAL COMPONENTS, BUYERS SHOULD PROVIDE ADEQUATE DESIGN, TESTING AND OPERATING SAFEGUARDS.

EXCEPT AS PROVIDED IN NATIONAL'S TERMS AND CONDITIONS OF SALE FOR SUCH PRODUCTS, NATIONAL ASSUMES NO LIABILITY WHATSOEVER, AND NATIONAL DISCLAIMS ANY EXPRESS OR IMPLIED WARRANTY RELATING TO THE SALE AND/OR USE OF NATIONAL PRODUCTS INCLUDING LIABILITY OR WARRANTIES RELATING TO FITNESS FOR A PARTICULAR PURPOSE, MERCHANTABILITY, OR INFRINGEMENT OF ANY PATENT, COPYRIGHT OR OTHER INTELLECTUAL PROPERTY RIGHT.

LIFE SUPPORT POLICY

NATIONAL'S PRODUCTS ARE NOT AUTHORIZED FOR USE AS CRITICAL COMPONENTS IN LIFE SUPPORT DEVICES OR SYSTEMS WITHOUT THE EXPRESS PRIOR WRITTEN APPROVAL OF THE CHIEF EXECUTIVE OFFICER AND GENERAL COUNSEL OF NATIONAL SEMICONDUCTOR CORPORATION. As used herein:

Life support devices or systems are devices which (a) are intended for surgical implant into the body, or (b) support or sustain life and whose failure to perform when properly used in accordance with instructions for use provided in the labeling can be reasonably expected to result in a significant injury to the user. A critical component is any component in a life support device or system whose failure to perform can be reasonably expected to cause the failure of the life support device or system or to affect its safety or effectiveness.

National Semiconductor and the National Semiconductor logo are registered trademarks of National Semiconductor Corporation. All other brand or product names may be trademarks or registered trademarks of their respective holders.

Copyright© 2008 National Semiconductor Corporation
For the most current product information visit us at www.national.com



**National Semiconductor
Americas Technical
Support Center**
Email:
new.feedback@nsc.com
Tel: 1-800-272-9959

**National Semiconductor Europe
Technical Support Center**
Email: europe.support@nsc.com
German Tel: +49 (0) 180 5010 771
English Tel: +44 (0) 870 850 4288

**National Semiconductor Asia
Pacific Technical Support Center**
Email: ap.support@nsc.com

**National Semiconductor Japan
Technical Support Center**
Email: jpn.feedback@nsc.com